

NAH 71 B-4 IE1

Abmessungen Drehstrom-Asynchronmotor / dimensions three phase asynchron motor IM B34A (mm)

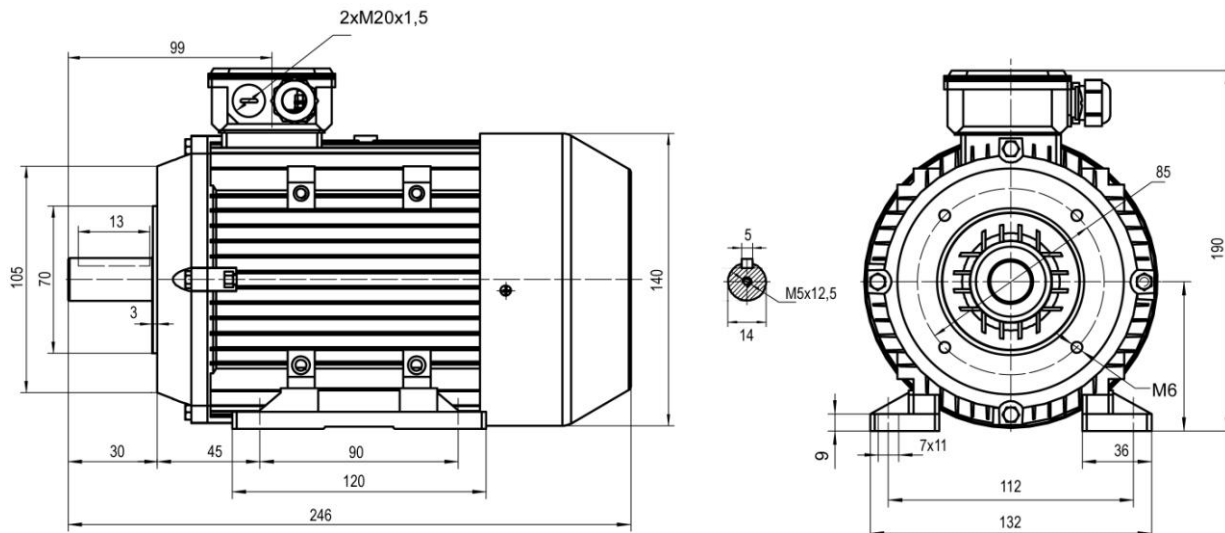

Technische Daten / technical dates

| | | | | | |
|-------------------------------------|----------------------|---------------|--|-----------------------------------|---------|
| Typ / type | NAH | 71 B-4 IE1 | Nennmoment / rated torque | (Nm) | 3,95 |
| Leistung / power | (kW) | 0,37 | Anlaufstrom-Nennstrom / starting current-rated current | (Ia/I _n) | 5,2 |
| Betriebsart / duty | | S1 | Anzugsmoment-Nennmoment starting torque-rated torque | (M _a /M _n) | 2,1 |
| Nennzahl/ speed (50 Hz) | (min ⁻¹) | 1330 | Kippmoment-Nennmoment Pull-out torque | (M _k /M _n) | 2,2 |
| Nennstrom / rated current | (A) | 1,93/1,12 | Massenträgheitsmoment / moment of inertia | (kgm ²) | |
| Spannung / voltage (+/-5%) | (V) | 230/400 (Δ/Y) | Umgeb.-temp./ ambient temperature | | 40°C |
| Frequenz / frequency | (Hz) | 50 | Lager / bearing | (DE) | 6202 ZZ |
| Wirkungsgrad / efficiency | (%) | 67,0 | | (NDE) | 6202 ZZ |
| Leistungsfaktor / power factor | (cos φ) | 0,75 | Schallpegel / noise level | dB (A) | |
| Schutzart / protection | | IP55 | Gewicht / weight | (kg) | 5,5 |
| Isolationsklasse / insulation class | | F | | | |

Schaltplan / connection diagram

