

NAH 71 B-4 IE1

Abmessungen Drehstrom-Asynchronmotor / dimensions three phase asynchron motor IM B3 (mm)

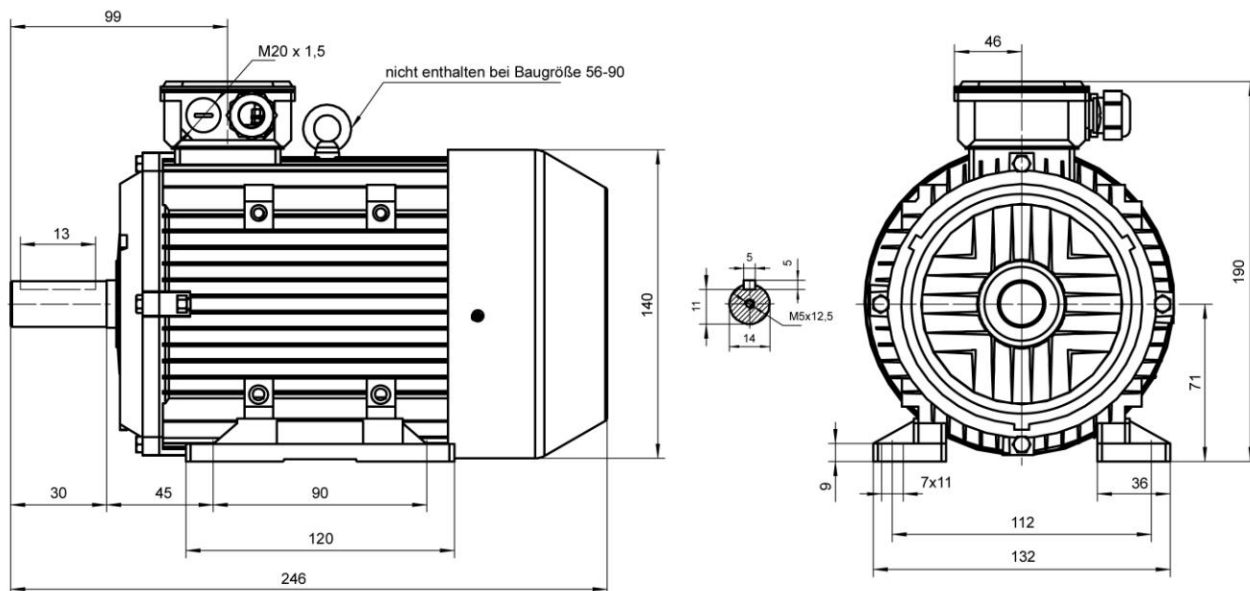

Technische Daten / technical dates

Typ / type	NAH	71 B-4 IE1	Nennmoment / rated torque	(Nm)	3,95
Leistung / power	(kW)	0,37	Anlaufstrom-Nennstrom / starting current-rated current	(Ia/I _n)	5,2
Betriebsart / duty		S1	Anzugsmoment-Nennmoment / starting torque-rated torque	(M _a /M _n)	2,1
Nennzahl/ speed (50 Hz)	(min ⁻¹)	1330	Kippmoment-Nennmoment / Pull-out torque	(M _k /M _n)	2,2
Nennstrom / rated current	(A)	1,93/1,12	Massenträgheitsmoment / moment of inertia	(kgm ²)	
Spannung / voltage (+/-5%)	(V)	230/400 (Δ/Y)	Umgeb.-temp./ ambient temperature		40°C
Frequenz / frequency	(Hz)	50	Lager / bearing	(DE)	6202 ZZ
Wirkungsgrad / efficiency	(%)	67,0		(NDE)	6202 ZZ
Leistungsfaktor / power factor	(cos φ)	0,75	Schallpegel / noise level	dB (A)	
Schutzart / protection		IP55	Gewicht / weight	(kg)	5,5
Isolationsklasse / insulation class		F			

Schaltplan / connection diagram

