

NAH 63 B-2 IE1

Abmessungen Drehstrom-Asynchronmotor / dimensions three phase asynchron motor IM B35 (mm)

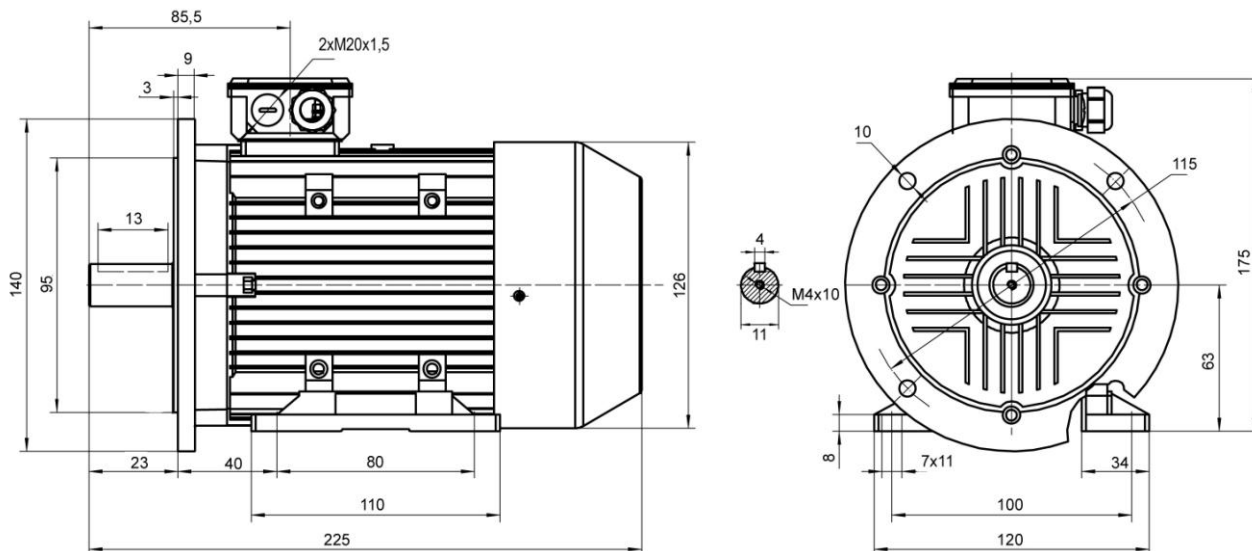

Technische Daten / technical dates

Typ / type	NAH	63 B-2 IE1	Nennmoment / rated torque	(Nm)	0,88
Leistung / power	(kW)	0,25	Anlaufstrom-Nennstrom / starting current-rated current	(Ia/I _n)	5,5
Betriebsart / duty		S1	Anzugsmoment-Nennmoment / starting torque-rated torque	(M _a /M _n)	2,2
Nennzahl/ speed (50 Hz)	(min ⁻¹)	2720	Kippmoment-Nennmoment / Pull-out torque	(M _k /M _n)	2,2
Nennstrom / rated current	(A)	1,14/0,66	Massenträgheitsmoment / moment of inertia	(kgm ²)	
Spannung / voltage (+/-5%)	(V)	230/400 (Δ/Y)	Umgeb.-temp./ ambient temperature		40°C
Frequenz / frequency	(Hz)	50	Lager / bearing	(DE)	6201 ZZ
Wirkungsgrad / efficiency	(%)	68,0		(NDE)	6201 ZZ
Leistungsfaktor / power factor	(cos φ)	0,81	Schallpegel / noise level	dB (A)	
Schutzart / protection		IP55	Gewicht / weight	(kg)	4,5
Isolationsklasse / insulation class		F			

Schaltplan / connection diagram

