

NAH 71 A-6 IE1

Abmessungen Drehstrom-Asynchronmotor / dimensions three phase asynchron motor IM B3 (mm)

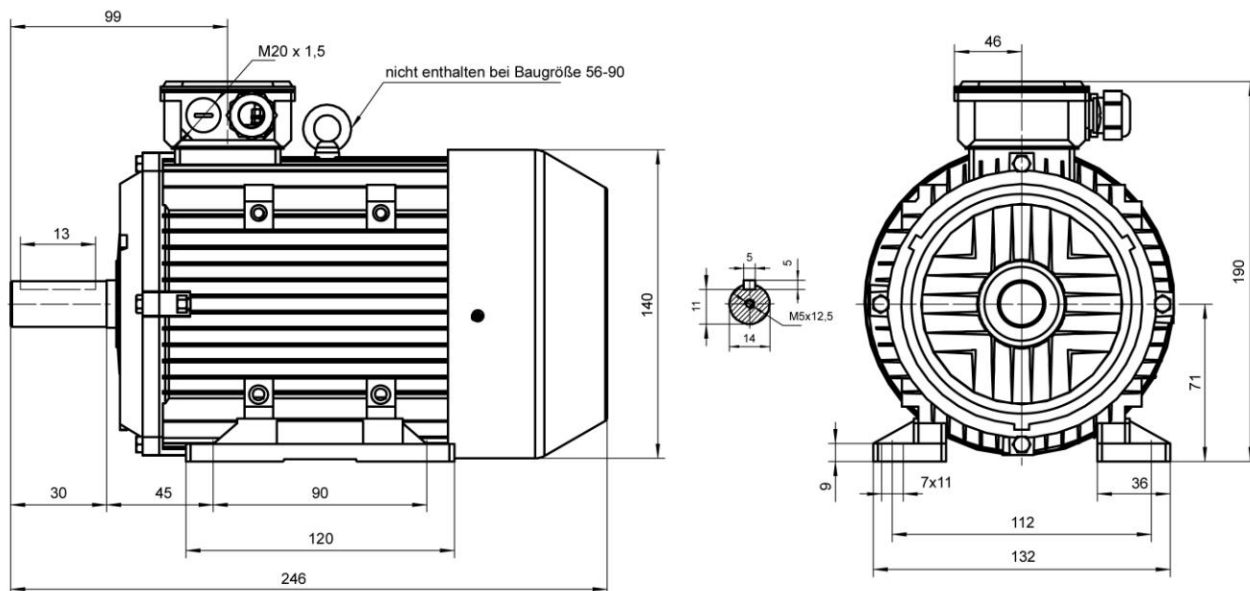

Technische Daten / technical dates

Typ / type	NAH	71 A-6 IE1	Nennmoment / rated torque	(Nm)	2,02
Leistung / power	(kW)	0,18	Anlaufstrom-Nennstrom / starting current-rated current	(Ia/I <sub>n</sub> )	4,0
Betriebsart / duty		S1	Anzugsmoment-Nennmoment / starting torque-rated torque	(M <sub>a</sub> /M <sub>n</sub> )	1,9
Nennzahl/ speed (50 Hz)	(min <sup>-1</sup> )	850	Kippmoment-Nennmoment / Pull-out torque	(M <sub>k</sub> /M <sub>n</sub> )	2,0
Nennstrom / rated current	(A)	1,28/0,74	Massenträgheitsmoment / moment of inertia	(kgm <sup>2</sup> )	
Spannung / voltage (+/-5%)	(V)	230/400 (Δ/Y)	Umgeb.-temp./ ambient temperature		40°C
Frequenz / frequency	(Hz)	50	Lager / bearing	(DE)	6202 ZZ
Wirkungsgrad / efficiency	(%)	56,0		(NDE)	6202 ZZ
Leistungsfaktor / power factor	(cos φ)	0,66	Schallpegel / noise level	dB (A)	
Schutzart / protection		IP55	Gewicht / weight	(kg)	6,7
Isolationsklasse / insulation class		F			

Schaltplan / connection diagram

