

NAH 63 A-4 IE1

Abmessungen Drehstrom-Asynchronmotor / dimensions three phase asynchron motor IM B5 (mm)

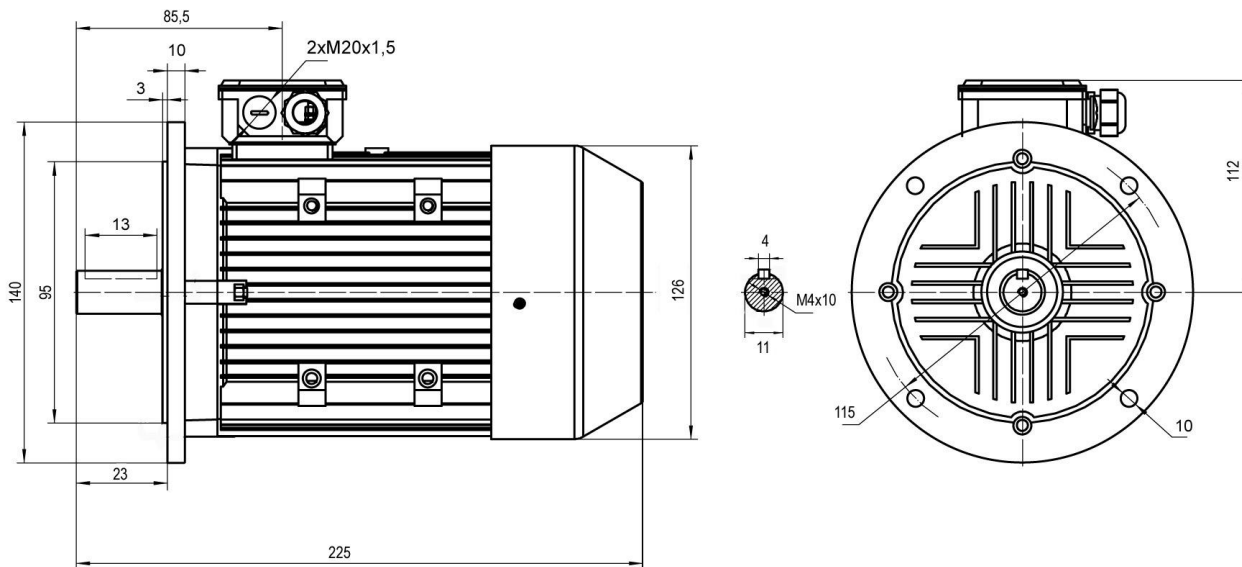

Technische Daten / technical dates

Typ / type	NAH	63 A-4 IE1	Nennmoment / rated torque	(Nm)	1,31
Leistung / power	(kW)	0,12	Anlaufstrom-Nennstrom / starting current-rated current	(Ia/In)	4,4
Betriebsart / duty		S1	Anzugsmoment-Nennmoment starting torque-rated torque	(Ma/Mn)	2,1
Nennzahl/ speed (50 Hz)	(min ⁻¹)	1310	Kippmoment-Nennmoment Pull-out torque	(Mk/Mn)	2,2
Nennstrom / rated current	(A)	0,76/0,44	Massenträgheitsmoment / moment of inertia	(kgm ²)	
Spannung / voltage (+/-5%)	(V)	230/400 (Δ/Y)	Umgeb.-temp./ ambient temperature		40°C
Frequenz / frequency	(Hz)	50	Lager / bearing	(DE)	6201 ZZ
Wirkungsgrad / efficiency	(%)	57,0	(NDE)		6201 ZZ
Leistungsfaktor / power factor	(cos φ)	0,72	Schallpegel / noise level	dB (A)	
Schutzart / protection		IP55	Gewicht / weight	(kg)	4,3
Isolationsklasse / insulation class		F			

Schaltplan / connection diagram

